

CARATTERISTICHE E VALORI SPILLI CONICI PER MOTOVEICOLI

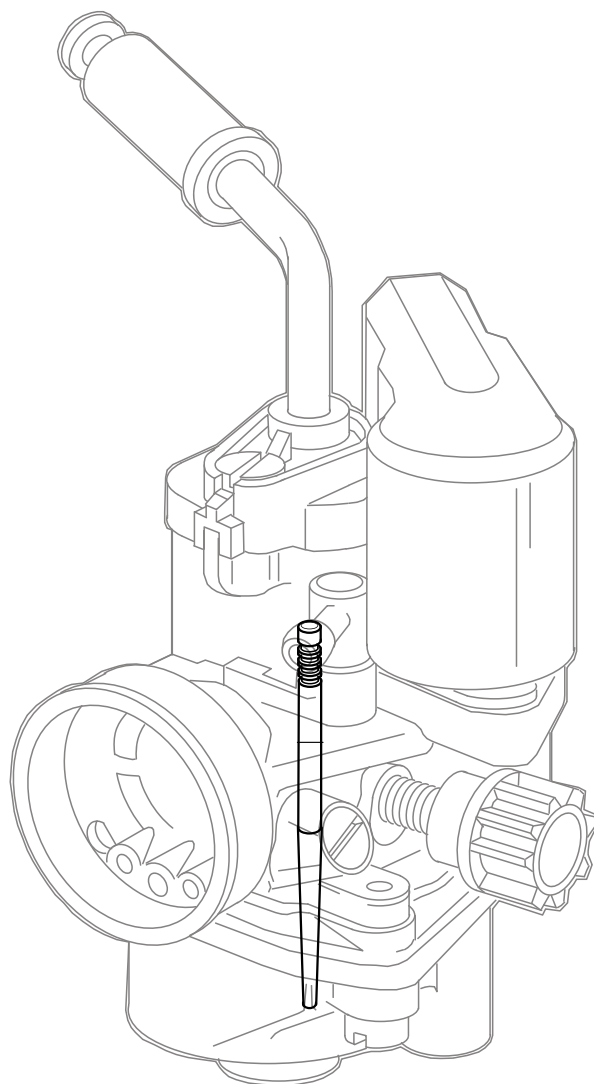

SPILLI CONICI

CARATTERISTICHE SPILLI CONICI SERIE A - M

SPILLI CONICI SERIE 13680 X 08 A Carburatore PHVA-PHBN

TIPO	VALORE X	Caratteristiche Esprese in mm.			
		ØA	ØB	C	D
A02	02	2	0,6	20	12
A07	07	2	1	18	14
A08	08	2	1	20	12
A10	10	2,02	0,6	18	14
A11	11	2,02	0,6	20	12
A12	12	2	1,79	20	12
A13	13	2	1,79	22	10
A14	14	2,02	1	18	14
A15	15	1,98	1,77	20	12
A18	18	2,04	0,61	21,9	10,07
A19	19	1,98	1,77	20,3	11,7
A20	20	2	1,6	20	12
A21	21	1,99	1,79	18,1	13,8
A23	23	1,98	1	18	14
A24	24	1,99	1	20	12
A25	25	2,02	1,4	20	12
A26	26	2	1,9	20	12
A27	27	1,98	1,8	20	12
A28	28	1,99	1,8	20	12
A29	29	2,02	1,2	20	12
A30	30	1,99	1,40	20	12
A31	31	1,98	1,40	20	12
A32	32	1,98	1,70	20	12
A33	33	2	1	21	11
A34	34	2	-	21	11
A35	35	2	1,60	18	14
A36	36	2,02	1,60	18	14
A37	37	2	1,20	18	14

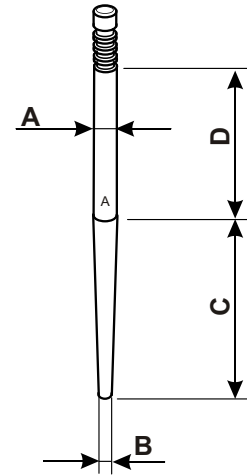

SPILLI CONICI SERIE 15377 X 08 M Carburatore PHVB

TIPO	VALORE X	Caratteristiche Esprese in mm.					
		ØA	ØB	C	D	ØF	G
M1	01	2	1,1	19,5	19,9		
M2	02	2,02	1,1	26	13,4	1,97	20
M3	03	2,02	1,1	20,5	18,9		
M4	04	2,02	1,1	21,5	17,9		
M5	05	2	0,6	19,5	19,9		
M6	06	2,02	1,1	22,5	16,9		
M7	07	2,02	0,6	23	16,4	1,97	21
M8	08	2		24	15,4		

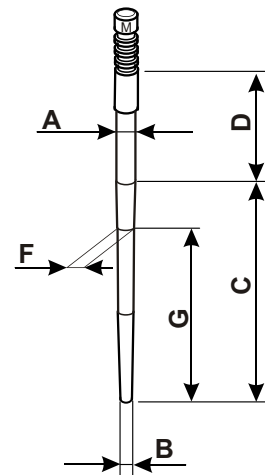

CARATTERISTICHE SPILLI CONICI SERIE X - W

TIPO	VALORE X	Caratteristiche Esprese in mm.				
		ØA	ØB	C	ØD	E
X1	1	2.48	1.20	26	-	-
X2	2	2.50	1.80	24	-	-
X3	3	2.46	1.60	22	-	-
X4	4	2.48	1.80	20	-	-
X5	5	2.46	1.80	24	-	-
X6	6	2.50	1.20	26	-	-
X7	7	2.50	1.80	20	-	-
X8	8	2.50	1.40	26	-	-
X9	9	2.50	1.40	18	-	-
X10	10	2.50	1.40	20	-	-
X11	11	2.50	1.40	22	-	-
X12	12	2.50	1.80	18	-	-
X13	13	2.50	1.80	22	-	-
X14	14	2.50	0.80	24	-	-
X15	15	2.50	0.80	26	-	-
X16	16	2.50	0.80	28	-	-
X17	17	2.50	1.20	24	-	-
X18	18	2.50	1.20	28	-	-
X19	19	2.48	1.00	28	-	-
X20	20	2.42	1.00	22	-	-
X21	21	2.50	1.00	20	-	-
X22	22	2.48	1.20	28.5	-	-
X23	23	2.46	1.20	26	-	-
X24	24	2.50	1.00	30	-	-
X25	25	2.50	1.80	25	-	-
X27	27	2.48	1.40	20	-	-
X28	28	2.50	1.20	26	2.38	20
X29	29	2.50	0.60	30	-	-
X30	30	2.50	1.00	28	2.30	20
X31	31	2.48	1.20	28	-	-
X32	32	2.48	1.80	24	-	-
X33	33	2.50	1.00	32	-	-
X34	34	2.48	1.20	29	2.34	15
X35	35	2.48	0.80	26	2.32	20
X36	36	2.53	0.60	30	-	-
X37	37	2.53	0.60	30	-	-
X38	38	2.48	1.20	28	2.28	20
X39	39	2.50	0.80	26	2.33	20
X40	40	2.50	0.80	27	2.33	24
X41	41	2.48	1.00	29	2.43	27
X42	42	2.53	0.65	29.25	-	-
X43	43	2.50	0.80	24	2.38	18
X44	44	2.46	1.80	22	-	-
X45	45	2.48	0.80	24.5	2.30	18
X46	46	2.50	1.20	23	-	-
X47	47	2.50	1.80	30	2.35	15
X48	48	2.47	1.80	29	-	-
X49	49	2.50	1.20	22	-	-
X50	50	2.50	1.20	25	-	-
X51	51	2.50	1.20	24	2.37	18
X52	52	2.52	0.98	29.46	-	-
X53	53	2.53	0.60	28	2.40	24
X54	54	2.50	1.30	28	2.35	20
X55	55	2.51	0.98	29.25	-	-
X56	56	2.50	0.80	26	2.36	22
X57	57	2.50	0.98	29.05	-	-
X58	58	2.50	0.60	30	-	-
X59	59	2.50	1.00	21	-	-
X60	60	2.54	1.00	28	-	-
X61	61	2.46	1.80	20	-	-
X62	62	2.50	1.00	30	2.31	22
X63	63	2.50	1.20	27	-	-
X64	64	2.50	1.30	30	2.31	22
X65	65	2.52	1.00	34	-	-
X66	66	2.53	0.98	29.65	-	-
X67	67	2.52	1.00	32	-	-
X68	68	2.45	1.80	28.14	-	-
X69	69	2.52	0.98	29.46	-	-
X70	70	2.52	0.65	29.09	-	-
X71	71	2.48	1.00	29	-	-
X72	72	2.52	1.02	29.55	-	-
X73	73	2.52	1.02	29.55	-	-
X74	74	2.52	1.60	30	-	-
X75	75	2.52	1.60	29	-	-
X76	76	2.52	1.60	29.36	-	-
X77	77	2.48	0.80	26	-	-
X78	78	2.52	1.11	29.22	-	-
X79	79	2.51	1.01	28.17	-	-
X80	80	2.50	1.20	26	-	-
X81	81	2.48	1.00	24	-	-
X82	82	2.53	0.98	29.46	-	-
X83	83	2.53	0.98	28.86	-	-
X84	84	2.52	0.98	29.46	-	-
X85	85	2.48	1.00	32	-	-
X86	86	2.50	1.60	29	-	-
X87	87	2.54	1.40	30	-	-
X88	88	2.50	1.20	28	-	-

○

□

□

□

○ □

□ = Costruito in alluminio anodizzato
○ = Differisce da X 36 per avere una lunghezza di 56,2

SPILLI CONICI SERIE 9477 X 08 X Carburatore PHBH

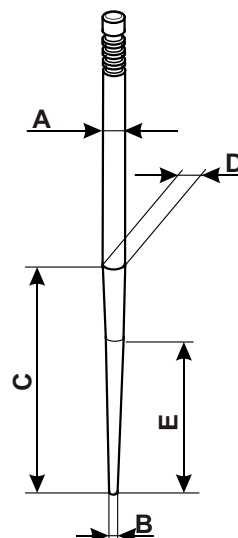

SPILLI CONICI SERIE 9595 X 08 W Carburatore PHBG

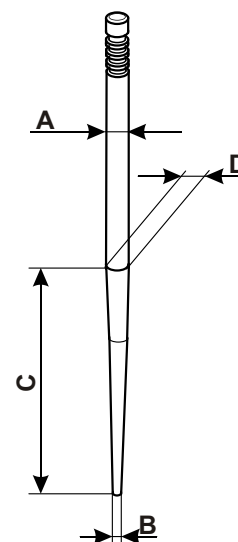

TIPO	VALORE X	Caratteristiche Esprese in mm.		
		ØA	ØB	C
W1	1	2.46	0.60	24
W2	2	2.46	0.60	22
W3	3	2.48	1.40	20
W4	4	2.48	1.40	18
W5	5	2.46	1.40	18
W6	6	2.50	1.00	24
W7	7	2.50	1.40	18
W8	8	2.50	1.40	16
W9	9	2.50	1.40	20
W10	10	2.50	1.80	16
W11	11	2.50	1.80	18
W12	12	2.50	1.80	20
W13	13	2.50	0.60	22
W14	14	2.50	0.60	24
W15	15	2.50	0.60	26
W16	16	2.50	1.00	22
W17	17	2.50	1.00	26
W18	18	2.48	0.60	24
W19	19	2.50	1.80	20
W20	20	2.50	1.60	24
W21	21	2.50	1.60	24
W22	22	2.50	0.60	26
W23	23	2.50	0.60	26
W24	24	2.50	1.80	24
W25	25	2.50	1.80	22
W26	26	2.50	0.98	24

□ = Costruito in alluminio anodizzato
○ = Differisce da W 15 per avere una lunghezza di 42,6

CARATTERISTICHE SPILLI CONICI SERIE K - U

SPILLI CONICI SERIE 8530 X 08 K

Carburatore

PHBE-PHF-PHM-PHSB-VHSB

TIPO	VALORE X	Caratteristiche Espresses in mm.					
		ØA	ØB	C	ØD	E	F
K1	1	2.45	1.75	37	-	-	-
K2	2	2.45	1.75	42	-	-	-
K3	3	2.50	1.50	39	-	-	-
K4	4	2.45	1.50	39	-	-	-
K5	5	2.45	1.50	37	-	-	-
K6	6	2.45	1.75	39	-	-	-
K7	7	2.45	1.25	39	-	-	-
K8	8	2.50	1.50	37	-	-	-
K9	9	2.45	1.50	42	-	-	-
K11	11	2.50	1.25	39	-	-	-
K12	12	2.48	1.75	32	-	-	-
K13	13	2.45	1.25	38	-	-	-
K14	14	2.48	1.75	33	-	-	-
K15	15	2.50	0.60	36	-	-	-
K16	16	2.50	1.75	39	-	-	-
K17	17	2.42	1.75	40	-	-	-
K18	18	2.50	1.40	38	-	-	-
K19	19	2.50	1.40	40	-	-	-
K20	20	2.50	1.40	42	-	-	-
K21	21	2.50	1.80	38	-	-	-
K22	22	2.50	1.80	40	-	-	-
K23	23	2.50	1.80	42	-	-	-
K24	24	2.50	1.20	38	2.13	18	-
K25	25	2.50	1.00	36	2.15	18	-
K27	27	2.50	1.80	44	-	-	-
K28	28	2.50	1.80	41	-	-	-
K29	29	2.45	1.25	42	-	-	-
K30	30	2.50	1.40	36	2.15	18	-
K31	31	2.45	1.50	36	-	-	-
K32	32	2.48	1.70	44	-	-	-
K33	33	2.50	1.80	44	-	-	-
K34	34	2.50	1.40	40	2.11	18	-
K35	35	2.50	1.40	43	-	-	-
K36	36	2.50	1.40	38	2.17	20	-
K37	37	2.50	1.40	39	2.12	18	-
K38	38	2.50	1.40	38	2.13	18	-
K39	39	2.48	1.45	36	2.28	26	-
K40	40	2.50	1.40	40	2.18	22	-
K41	41	2.50	1.40	40	2.14	22	-
K42	42	2.50	1.40	38	2.16	22	-
K43	43	2.50	1.40	42	2.16	26	-
K44	44	2.50	1.40	39	2.06	20	-
K45	45	2.48	1.30	36	2.28	26	-
K46	46	2.50	1.40	40	2.15	20	-
K48	48	2.48	1.60	36	2.25	25	11
K49	49	2.50	1.40	39	2.20	26	-
K50	50	2.50	1.40	39	2.27	26	-
K51	51	2.52	1.40	43	-	-	-
K52	52	2.50	1.60	36	2.25	25	11
K53	53	2.52	1.60	36	2.25	25	11
K54	54	2.48	1.50	40	2.108	18	-
K56	56	2.50	1.20	38	2.17	20	-
K57	57	2.50	1.40	37	2.232	26	-
K58	58	2.46	1.60	36	2.25	25	11
K59	59	2.50	1.40	39	2.23	24	-
K60	60	2.46	1.60	39	2.13	25	11
K61	61	2.44	1.60	39	2.13	25	11
K62	62	2.48	1.60	39	2.13	25	11
K63	63	2.46	1.60	39	2.10	25	11
K65	65	2.46	1.60	39	2.16	25	11
K66	66	2.44	1.60	39	2.16	25	11
K67	67	2.44	1.60	39	2.10	25	11
K68	68	2.42	1.60	39	2.07	25	11
K69	69	2.48	1.60	39	2.10	25	11
K70	70	2.42	1.60	39	2.04	25	11
K71	71	2.44	1.60	39	2.07	25	11
K72	72	2.50	1.20	38	2.20	22	-
K76	76	2.46	1.55	39	2.10	25	11
K77	77	2.46	1.60	39	2.07	25	11
K78	78	2.48	1.60	39	2.07	25	11
K79	79	2.48	1.60	36	2.07	25	11
K80	80	2.40	1.60	39	-	-	-
K81	81	2.44	1.55	39	2.07	25	11
K82	82	2.48	1.55	39	2.10	25	11
K83	83	2.44	1.55	39	2.04	25	11
K84	84	2.48	1.50	39	2.10	25	11
K86	86	2.46	1.50	39	2.07	25	11
K87	87	2.48	1.45	39	2.10	25	11
K88	88	2.56	1.43	32.4	2.12	16.2	-
K89	89	2.48	1.50	39	2.07	25	11
K91	91	2.47	1.40	39	2.27	26	-
K92	92	2.50	1.60	38	-	-	-
K93	93	2.50	1.60	40	-	-	-
K94	94	2.50	1.65	38	-	-	-
K95	95	2.50	1.65	40	-	-	-
K96	96	2.50	1.75	42	-	-	-
K97	97	2.50	1.80	44.5	-	-	-
K98	98	2.52	1.80	41	-	-	-

□ = Differisce da K 27 per avere una lunghezza di 70.5

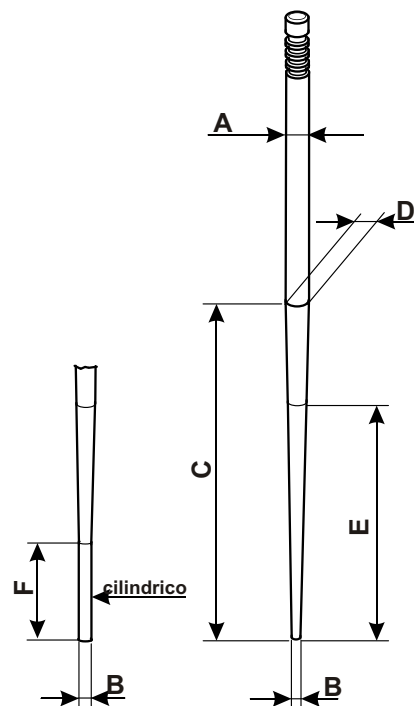

SPILLI CONICI SERIE 9713 X 08 U Carburatore PHBE...P-VHSA

TIPO	VALORE X	Caratteristiche Espresses in mm.				
		ØA	ØB	C	ØD	E
U1	1	2.46	1.40	40	-	-
U2	2	2.50	1.80	40	-	-
U3	3	2.50	1.40	34	-	-
U4	4	2.50	1.40	38	-	-
U5	5	2.50	1.40	40	-	-
U6	6	2.50	1.40	42	-	-
U7	7	2.50	1.80	38	-	-
U8	8	2.50	1.80	42	-	-
U9	9	2.48	1.00	28	2.16	18
U10	10	2.50	1.00	30	2.06	18
U11	11	2.50	1.00	28	2.11	16
U12	12	2.50	1.40	32	-	-
U13	13	2.45	1.20	28	-	-
U14	14	2.48	0.60	28	2.23	18
U15	15	2.50	1.20	32	-	-
U16	16	2.50	1.80	32	-	-
U17	17	2.50	0.60	36	-	-
U18	18	2.48	1.00	34	-	-
U19	19	2.44	1.00	32.6	-	-
U20	20	2.44	1.00	34.5	-	-
U21	21	2.44	1.00	36	-	-
U22	22	2.50	1.00	36.5	-	-
U23	23	2.46	1.00	36.5	-	-
U24	24	2.46	1.00	34	-	-
U25	25	2.48	1.00	36.5	-	-

CARATTERISTICHE SPILLI CONICI SERIE E - D

SPILLI CONICI SERIE 2343 X 08 E Carburatore VHBZ-PHSA

TIPO	VALORE X	Caratteristiche Espresses in mm.					
		ØA	ØB	C	ØD	E	F
E1	1	2.45	2.00	19	-	-	65
E2	2	2.42	1.30	20	-	-	65
E3	3	2.50	1.30	23	-	-	65
E4	4	2.45	1.30	22	-	-	65
E5	5	2.43	1.30	21.5	-	-	65
E6	6	2.42	2.00	18	-	-	65
E7	7	2.40	2.00	17	-	-	65
E8	8	2.50	0.50	23	-	-	65
E9	9	2.50	0.50	20	-	-	62
E10	10	2.45	0.50	19.5	-	-	62
E11	11	2.42	0.50	19.2	-	-	62
E12	12	2.45	1.25	19.2	-	-	62
E13	13	2.50	1.30	25	-	-	65
E14	14	2.45	0.50	21.5	-	-	62
E15	15	2.43	1.30	22.5	-	-	65
E16	16	2.45	0.50	22.5	-	-	65
E17	17	2.45	1.70	20	-	-	65
E18	18	2.50	1.30	26	-	-	65
E19	19	2.42	1.00	21	-	-	65
E20	20	2.45	1.70	17	-	-	62
E22	22	2.42	1.70	17	-	-	65
E23	23	2.45	1.70	17	-	-	65
E24	24	2.45	1.70	21.5	-	-	65
E25	25	2.45	0.75	19	-	-	65
E26	26	2.45	1.25	18	-	-	65
E27	27	2.42	1.25	18	-	-	65
E28	28	2.45	0.75	22	-	-	65
E29	29	2.48	1.25	23	-	-	65
E30	30	2.40	1.90	17	-	-	65
E31	31	2.42	1.50	18	-	-	65
E32	32	2.45	1.00	21	-	-	65
E33	33	2.50	1.70	21	-	-	65
E35	35	2.42	0.75	18	-	-	65
E36	36	2.45	1.60	24.5	-	-	70
E37	37	2.45	1.50	17	-	-	65
E38	38	2.50	1.00	26	-	-	65
E39	39	2.50	0.95	25	-	-	65
E40	40	2.42	1.25	24	-	-	65
E41	41	2.45	1.50	32	-	-	65
E42	42	2.50	1.50	18	-	-	65
E43	43	2.45	1.25	20	-	-	65
E51	51	2.45	1.50	20	-	-	65
E52	52	2.50	1.70	29	2.19	13	65

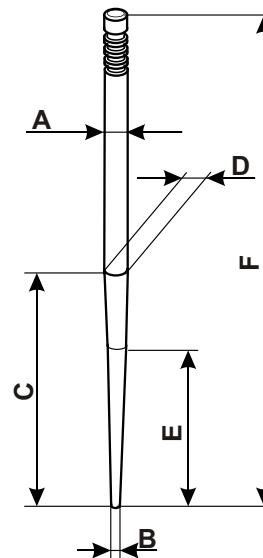

SPILLI CONICI SERIE 2265 X 08 D Carburatore PHBL

TIPO	VALORE X	Caratteristiche Espresses in mm.				
		ØA	ØB	C	ØD	E
D1	1	2.45	1.50	15.4	-	-
D3	3	2.42	1.50	14	-	-
D21	21	2.50	1.80	20.2	-	-
D22	22	2.50	1.40	18	-	-
D23	23	2.46	1.00	22	-	-
D24	24	2.50	0.60	20	-	-
D25	25	2.50	1.40	16	-	-
D26	26	2.50	1.40	20	-	-
D27	27	2.50	1.80	16	-	-
D28	28	2.50	1.80	18	-	-
D29	29	2.50	1.80	20	-	-
D30	30	2.50	0.60	18	-	-
D31	31	2.50	0.60	22	-	-
D32	32	2.50	1.00	18	-	-
D33	33	2.50	1.00	20	-	-
D34	34	2.50	1.00	22	-	-
D35	35	2.46	1.40	18	-	-
D36	36	2.50	1.40	22	-	-
D37	37	2.50	1.40	24	-	-
D38	38	2.50	1.00	26	-	-
D39	39	2.50	0.95	25	-	-
D40	40	2.48	1.00	24	-	-
D41	41	2.52	1.00	24.5	-	-
D42	42	2.46	0.60	24	2.295	18
D43	43	2.50	0.60	26	2.227	18
D44	44	2.48	1.60	24	-	-
□ D45	45	2.50	0.60	26	2.227	18
D46	46	2.50	1.00	24	-	-
D47	47	2.52	1.40	26	-	-
D48	48	2.50	0.80	28	-	-
D49	49	2.50	1.40	26	-	-

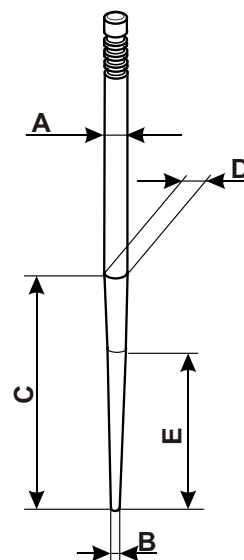

□ = Costruito in alluminio anodizzato